

# Jasper II

**KING**<sup>®</sup>  
L I V I N G



kingliving.com

# Jasper II Components

## Platforms

D1040 (41") H240 (9.5")

### P78



780 (30.75")

### P104



1040 (41")

### P130

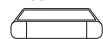

1300 (51.25")

### P156

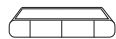

1560 (61.25")

### P182

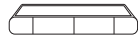

1820 (71.75")

### P208



2080 (82")

### P234



2340 (92.25")

### P260



2600 (102.25")

## Platforms Deep

D1300 (51.25") H240 (9.5")

### P104D



1040 (41")

### P130D

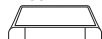

1300 (51.25")

### P182D



1820 (71.75")

### P208D



2080 (82")

### P234D

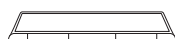

2340 (92.25")

### P130 CORNER

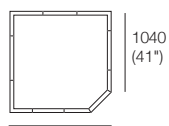

1300 (51.25")

1040 (41")

## Seat Cushions

D1040 (41") H200 (7.75")

### C104D



1040 (41")

### C156D

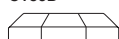

1560 (61.5")

### C182D

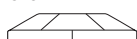

1820 (71.75")

### C208D

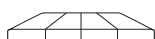

2080 (82")

### C104 78 CORNER

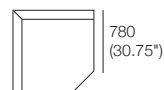

1040 (41")

780 (30.75")

### S Ottoman Platform

D780 (30.75") H240 (9.5")

### S Ottoman 104-D78



1040 (41")

## Seat Cushions

D780 (30.75") H200 (7.75")

### C78



780 (30.75")

### C91



910 (35.75")

### C104



1040 (41")

### C156

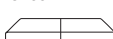

1560 (61.5")

### C182

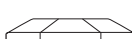

1820 (71.75")

### C208

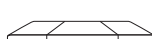

2080 (82")

## Storage Bases

D1040 (41") H240 (9.5")

### S Base 182 S156 RH

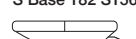

1820 (71.75")

### S Base 182 S156 LH

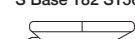

1820 (71.75")

### S Base 234 S208 RH

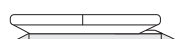

2340 (92.25")

### S Base 234 S208 LH



2340 (92.25")

### S Base 182 S78 RH



1820 (71.75")

### S Base 182 S78 LH



1820 (71.75")

## Storage Bases Deep

D1300 (51.25") H240 (9.5")

### S Base 208D S104 RH



2080 (82")

### S Base 208D S104 LH



2080 (82")

# Components & Accessories

## Arms / Backs

W260 (10.25") H310 (12.25")

### A78



### A78 SMART



### A104



### A104 SMART



### A130

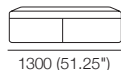

### A130 SMART

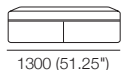

### A156

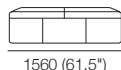

### A156 SMART



### A182

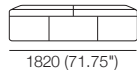

### A182 SMART

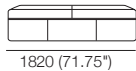

### A208

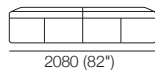

### A208 SMART

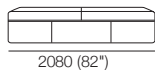

## Timber Veneer Shelves

W260 (10.25") H310 (12.25")

### T78 Timber Veneer T78 Charge



### T104 Timber Veneer T104 Charge

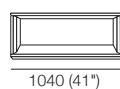

### T208 Timber Veneer

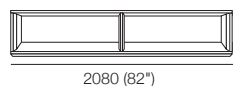

### Back Cushions

#### Front View

H500 (19.75")

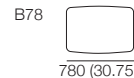

### Leather Back Cushions

Back View Detail: Bolster  
Stitching / Tricot / Perforation



## Media Console

### MC52

D1040 (41")

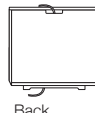
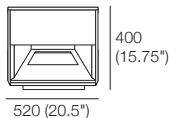

### MC38

D1040 (41")

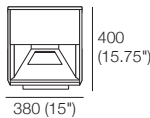

## Sonos SPEAKER Bracket

Stainless Steel / Black

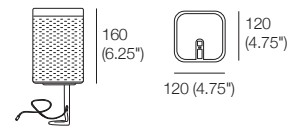

## RND CHARGE TrayTable

Timber Veneer

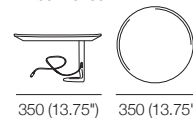

## Tray CARRARA 350

Carrara Marble

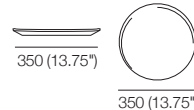

## Tray Timber 350

Timber Veneer

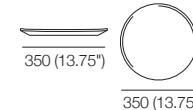

## Sofa Light 1214

Timber Veneer

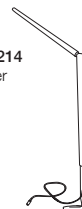

## RND TrayTable CARRARA

Carrara Marble

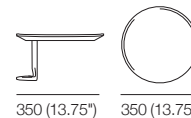

## RND TrayTable

Timber Veneer

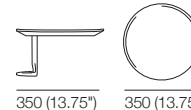

## Bed Brackets





DT201 8567 V5

Effective March 2019. Use Magic Joiner M115. Timber Veneer Shelves, Tables, Trays and Sofa Light available in King Living timber finishes. Back Cushions sold separately – price extra. As King Living has a policy of continuous improvement, changes to products and specifications may be made without prior notice. Images and drawings are representative of design only. Accessories not included.

# Jasper II Packages

**KING**<sup>®</sup>  
L I V I N G



[kingliving.com](http://kingliving.com)

# Jasper II Packages

## Packages: 13 + 13 SMART\*

2x P182, 2x C156, 1x A104, 1x A156,  
1x A78, 3x B78. Shelf Options\*: Standard or Charge  
1x T104, 1x T78 (\*Shelves not included – price extra)

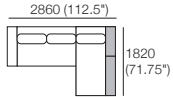

## Packages: 13 SLH + 13 SLH SMART\*

1x S Base 182 S156 RH, 1x S Base 182 S78 LH,  
1x A104, 1x A156, 1x A78, 3x B78  
Shelf Options\*: Standard or Charge  
1x T104, 1x T78 (\*Shelves not included – price extra)

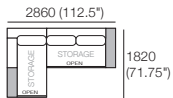

## Packages: 13 SRH + 13 SRH SMART\*

1x S Base 182 S156 LH, 1x S Base 182 S78 RH,  
1x A104, 1x A156, 1x A78, 3x B78  
Shelf Options\*: Standard or Charge  
1x T104, 1x T78 (\*Shelves not included – price extra)

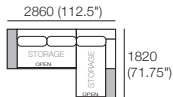

## Packages: 1A + 1A SMART\*

1x P234, 1x P208D, 2x C104, 1x C182D, 1x A208,  
2x A104, 3x B104. Shelf Options\*: Standard or Charge  
2x T104 (\*Shelves not included – price extra)

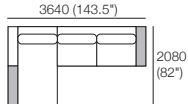

## Packages: 13U + 13U SMART\*

2x P182, 2x C156, 2x A104,  
1x A156, 2x A78, 3x B78

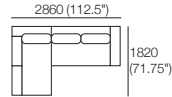

## Packages: 13U SLH + 13U SLH SMART\*

1x S Base 182 S156 RH, 1x S Base 182 S78 LH,  
1x A156, 2x A104, 2x A78, 3x B78

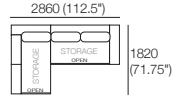

## Packages: 13U SRH + 13U SRH SMART\*

1x S Base 182 S156 LH, 1x S Base 182 S78 RH,  
1x A156, 2x A104, 2x A78, 3x B78

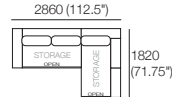

## Packages: 1A SLH + 1A SLH SMART\*

1x S Base 208D S104 LH, 1x S Base 234 S208 RH, 1x A208,  
2x A104, 3x B104. Shelf Options\*: Standard or Charge  
2x T104 (\*Shelves not included – price extra)

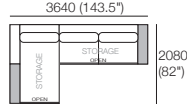

## Packages: 9 + 9 SMART\*

1x P234, 1x P208, 2x C104, 1x C182, 2x A104,  
1x A208, 2x B104, 1x B78. Shelf Options\*: Standard or Charge  
1x T104, 1x T78 (\*Shelves not included – price extra)

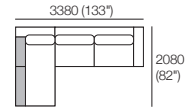

## Packages: 9 SLH S234 + 9 SLH S234 SMART\*

1x S Base 234 S208 RH, 1x P208, 1x C182, 1x A208,  
2x A104, 2x B104, 1x B78. Shelf Options\*: Standard or Charge  
1x T104, 1x T78 (\*Shelves not included – price extra)

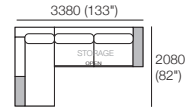

## Packages: 9 SRH S234 + 9 SRH S234 SMART\*

1x S Base 234 C208 LH, 1x P208, 1x C182,  
1x A208, 2x A104, 2x B104, 1x B78  
Shelf Options\*: Standard or Charge  
1x T104, 1x T78 (\*Shelves not included – price extra)

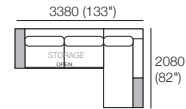

## Packages: 1A SRH + 1A SRH SMART\*

1x S Base 208D S104 RH, 1x S Base 234 S208 LH, 1x A208,  
2x A104, 3x B104. Shelf Options\*: Standard or Charge  
2x T104 (\*Shelves not included – price extra)

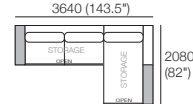

## Packages: 7 + 7 SMART\*

1x P208, 1x P182, 1x P234, 1x C182, 1x C156,  
2x C104, 3x A104, 1x A78, 1x A208, 2x B104, 2x B78  
Shelf Options\*: Standard or Charge  
1x T104, 2x T78 (\*Shelves not included – price extra)

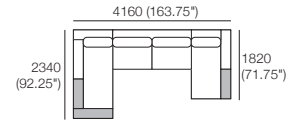

## Packages: 7 SLH 182 + 7 SLH 182 SMART\*

1x S Base 182 S78 LH, 1x P234, 1x P208, 1x C182,  
2x C104, 1x A208, 3x A104, 1x A78, 2x B104, 2x B78  
Shelf Options\*: Standard or Charge  
1x T104, 2x T78 (\*Shelves not included – price extra)

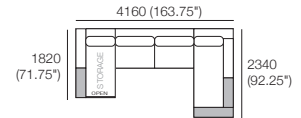

## Packages: 7 SRH 182 + 7 SRH 182 SMART\*

1x S Base 182 S78 RH, 1x P234, 1x P208, 1x C182,  
2x C104, 1x A208, 3x A104, 1x A78, 2x B104, 2x B78  
Shelf Options\*: Standard or Charge  
1x T104, 2x T78 (\*Shelves not included – price extra)

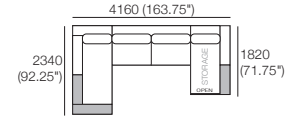

# Jasper II Packages 1A

**KING**<sup>®</sup>  
L I V I N G



[kingliving.com](http://kingliving.com)

# Jasper II Packages 1A

## Package: 1A

Components: 1x P234, 1x P208D, 2x C104, 1x C182D, 1x A208,  
2x A104, 3x B104

Shelf Options\*: Standard or Charge

2x T104 (\*Shelves not included – price extra)

Configurations:

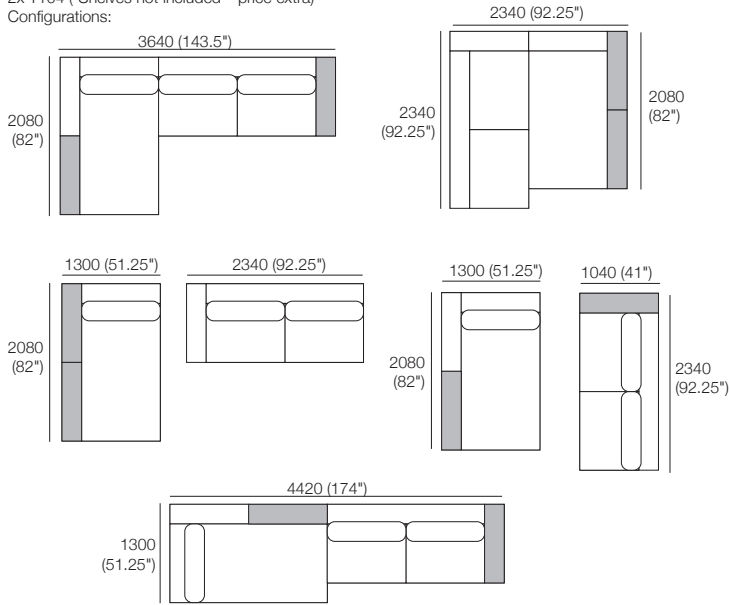

## Package: 1A SMART

Components: 1x P234, 1x P208D, 2x C104, 1x C182D,  
1x A208 SMART, 2x A104 SMART, 3x B104

Shelf Options\*: Standard or Charge

2x T104 (\*Shelves not included – price extra)

Configurations:

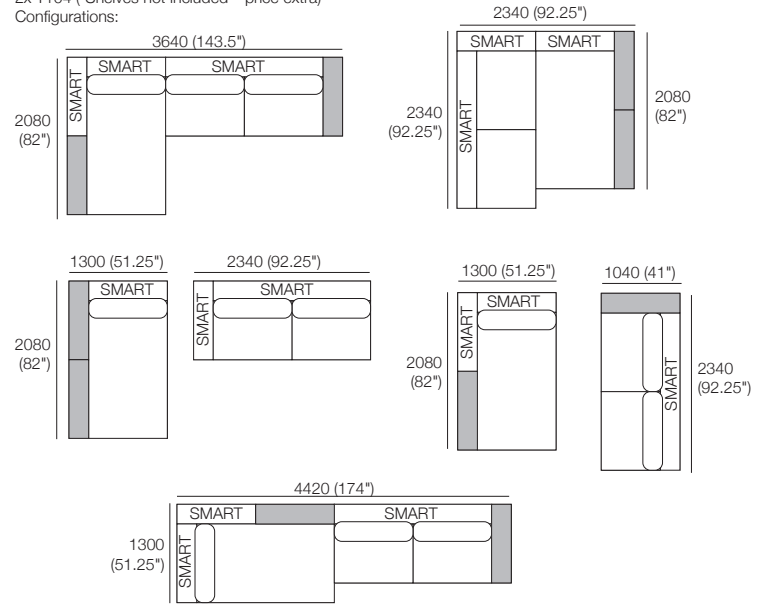



# Jasper II Packages 1A

## Package: 1A SLH

Components: 1x SBase 208D S104 LH, 1x SBase 234 S208 RH,  
1x A208, 2x A104, 3x B104

Shelf Options\*: Standard or Charge

2x T104 (\*Shelves not included – price extra)

Configurations:

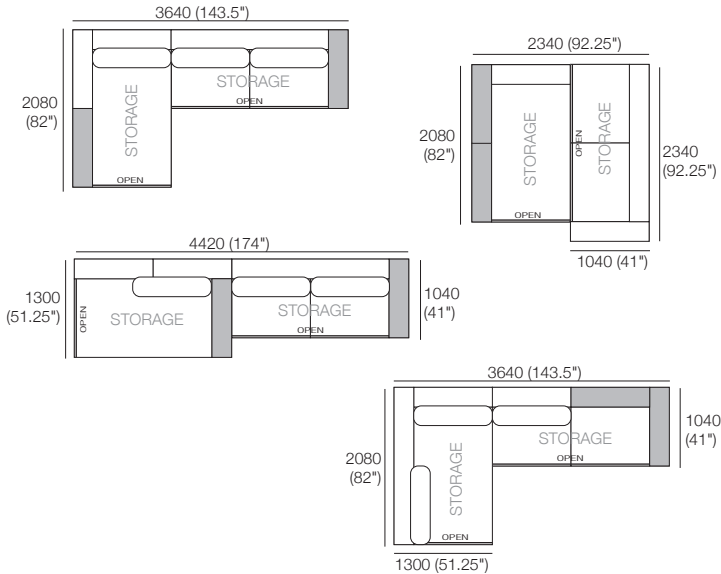

## Package: 1A SLH SMART

Components: 1x SBase 208D S104 LH, 1x SBase 234 S208 RH,  
1x A208 SMART, 2x A104 SMART, 3x B104

Shelf Options\*: Standard or Charge

2x T104 (\*Shelves not included – price extra)

Configurations:

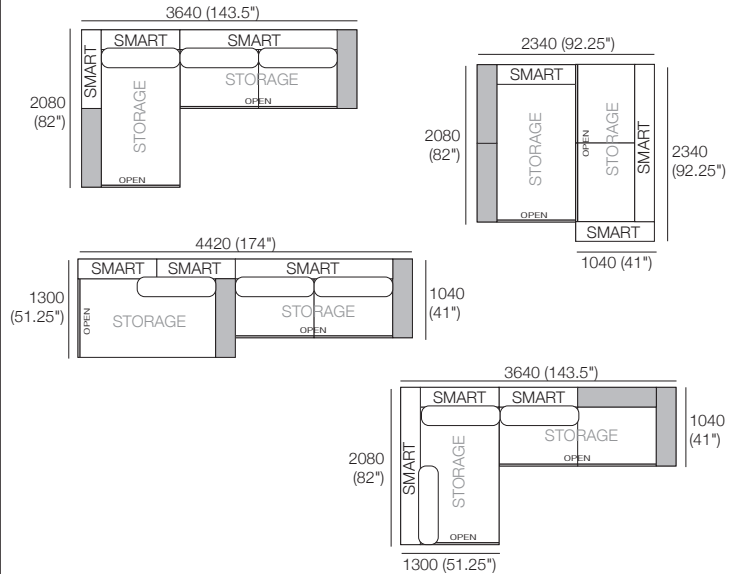

# Jasper II Packages 1A

## Package: 1A SRH

Components: 1x SBase 208D S104 RH, 1x SBase 234 S208 LH, 1x A208,  
2x A104, 3x B104

Shelf Options\*: Standard or Charge

2x T104 (\*Shelves not included – price extra)

Configurations:

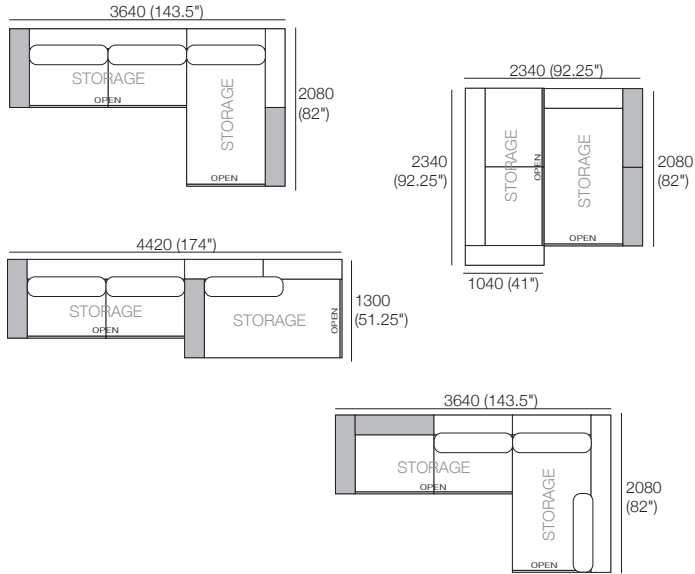

## Package: 1A SRH SMART

Components: 1x SBase 208D S104 RH, 1x SBase 234 S208 LH, 1x A208 SMART,  
2x A104 SMART, 3x B104

Shelf Options\*: Standard or Charge

2x T104 (\*Shelves not included – price extra)

Configurations:

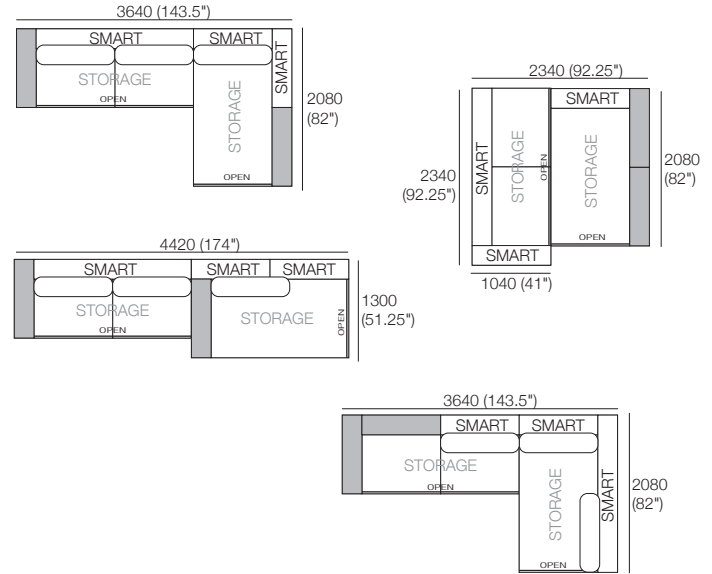

# Jasper II Packages 7

**KING**<sup>®</sup>  
L I V I N G



[kingliving.com](http://kingliving.com)

DT2018647 V2

# Jasper II Packages 7

**Packages: 7 + 7 SMART\*** (\*SMART Arms replace STD Arms)

Components: 1x P208, 1x P182, 1x P234, 1x C182, 1x C156, 2x C104,

3x A104, 1x A78, 1x A208, 2x B104, 2x B78

Shelf Options\*: Standard or Charge

1x T104, 2x T78 (\*Shelves not included – price extra)

Configurations:

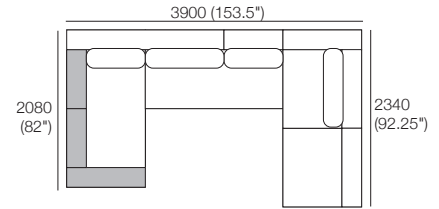
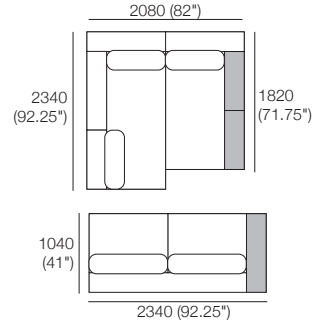
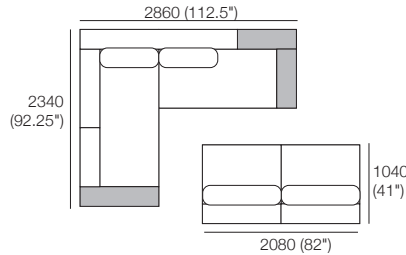
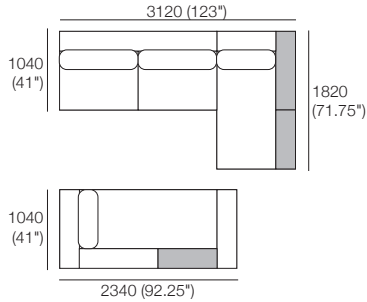
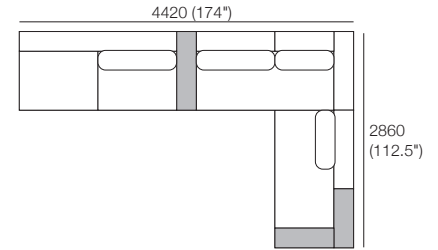
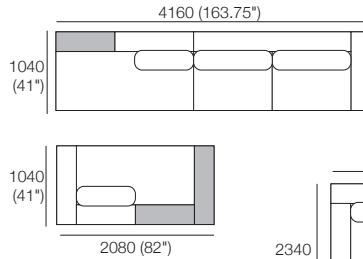
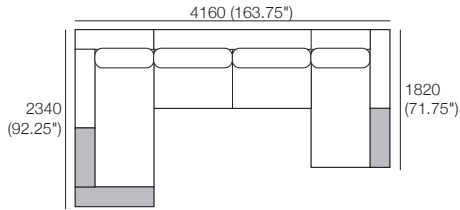

Effective April 2020. Use Magic Joiner M115. \*Shelf Options: Standard or Charge (not included in package – price extra) available in selected King Living Timber Finishes. \*SMART Packages: SMART Arms replace STD Arms. As King Living has a policy of continuous improvement, changes to products and specifications may be made without prior notice. Images and drawings are representative of design only. Accessories not included.

# Jasper II Packages 7

**Packages: 7 SLH182 + 7 SLH182 SMART\*** (\*SMART Arms replace STD Arms)  
 Components: 1x SBase 182 S78 LH, 1x P234, 1x P208, 1x C182, 2x C104,  
 1x A208, 3x A104, 1x A78, 2x B104, 2x B78  
 Shelf Options\*: Standard or Charge  
 1x T104, 2x T78 (\*Shelves not included – price extra)  
 Configurations:

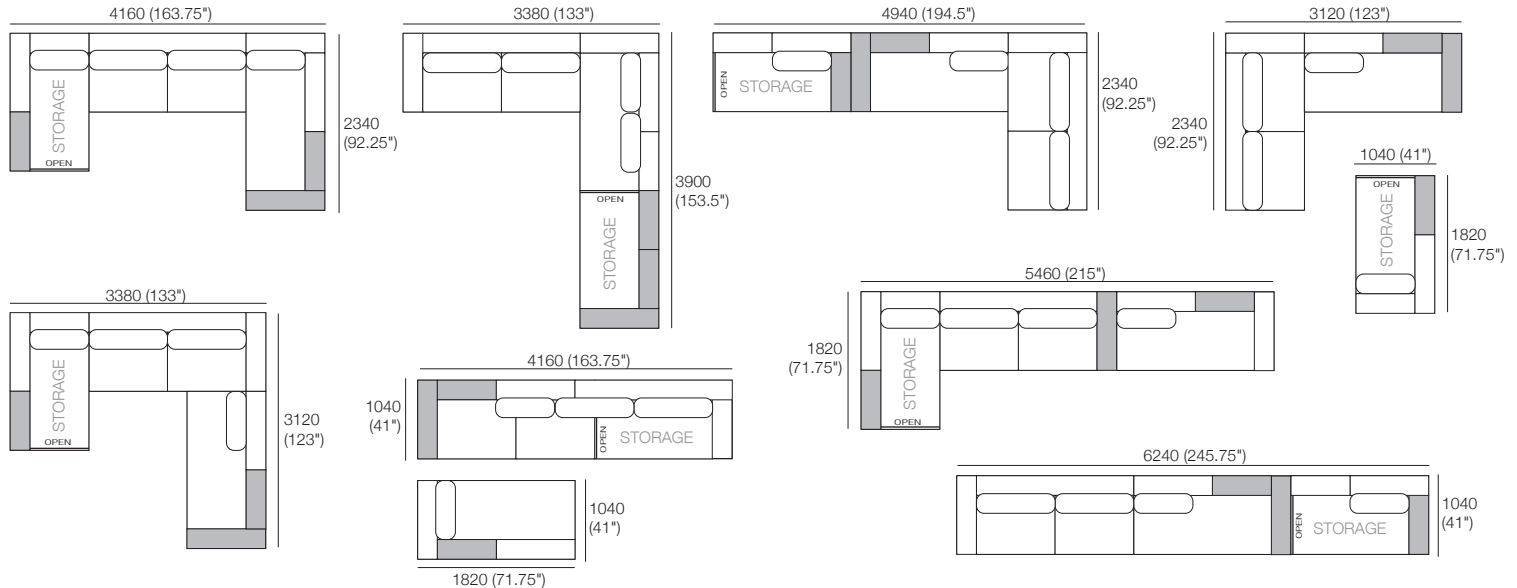

Effective April 2020. Use Magic Joiner M115. \*Shelf Options: Standard or Charge (not included in package – price extra) available in selected King Living Timber Finishes. \*SMART Packages: SMART Arms replace STD Arms. As King Living has a policy of continuous improvement, changes to products and specifications may be made without prior notice. Images and drawings are representative of design only. Accessories not included.

# Jasper II Packages 7

**Packages: 7 SRH182 + 7 SRH182 SMART\*** (\*SMART Arms replace STD Arms)  
 Components: 1x SBase 182 S78 RH, 1x P234, 1x P208, 1x C182, 2x C104,  
 1x A208, 3x A104, 1x A78, 2x B104, 2x B78  
 Shelf Options\*: Standard or Charge  
 1x T104, 2x T78 (\*Shelves not included – price extra)  
 Configurations:

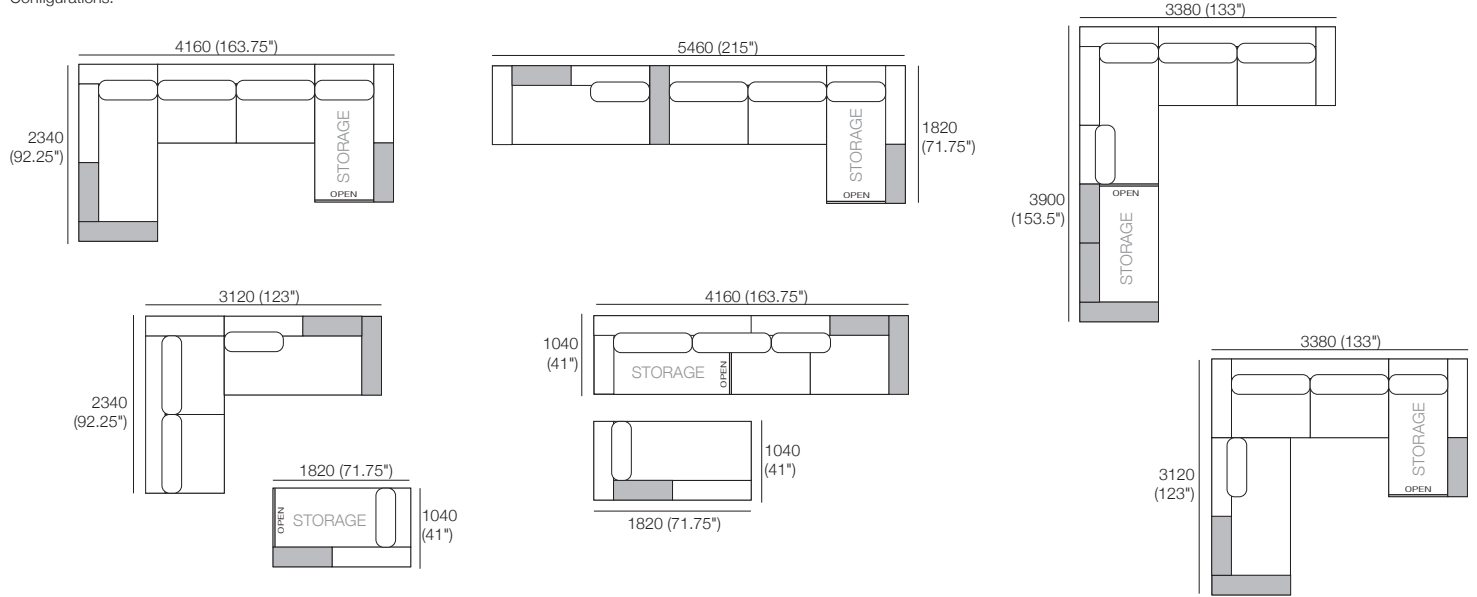

Effective April 2020. Use Magic Joiner M115. \*Shelf Options: Standard or Charge (not included in package – price extra) available in selected King Living Timber Finishes. \*SMART Packages: SMART Arms replace STD Arms. As King Living has a policy of continuous improvement, changes to products and specifications may be made without prior notice. Images and drawings are representative of design only. Accessories not included.

# Jasper II Packages 9

**KING**<sup>®</sup>  
L I V I N G



[kingliving.com](http://kingliving.com)

# Jasper II Packages 9

## Package: 9

Components: 1x P234, 1x P208, 2x C104, 1x C182, 2x A104, 1x A208, 2x B104, 1x B78

Shelf Options\*: Standard or Charge

1x T104, 1x T78 (\*Shelves not included – price extra)

Configurations:

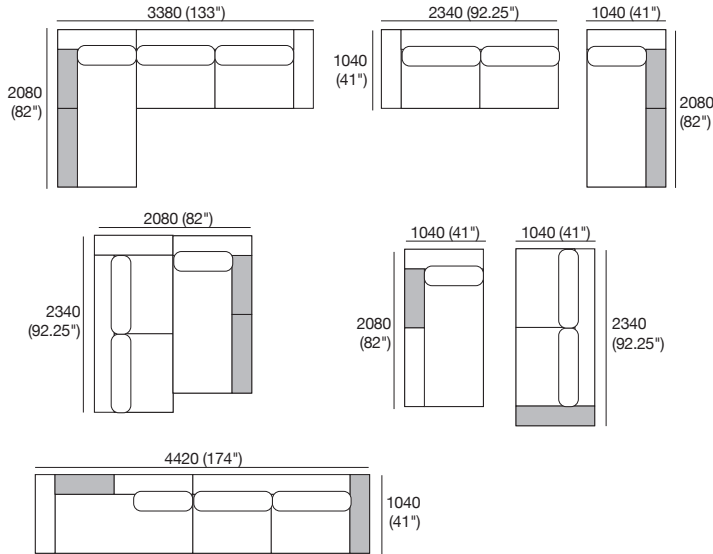

## Package: 9 SMART

Components: 1x P234, 1x P208, 2x C104, 1x C182, 2x A104 SMART, 1x A208 SMART, 2x B104, 1x B78

Shelf Options\*: Standard or Charge

1x T104, 1x T78 (\*Shelves not included – price extra)

Configurations:

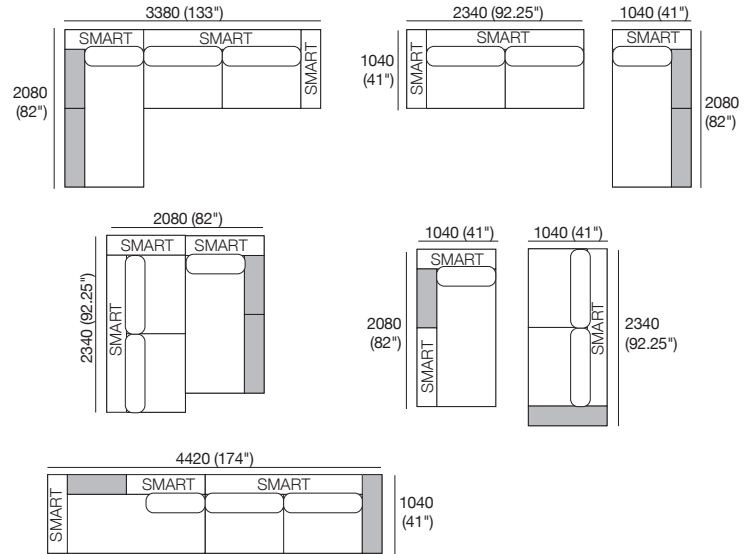



# Jasper II Packages 9

## Package: 9 SLH S234

Components: 1x SBase 234 S208 RH, 1x P208, 1x C182, 1x A208, 2x A104, 2x B104, 1x B78

Shelf Options\*: Standard or Charge

1x T104, 1x T78 (\*Shelves not included – price extra)

Configurations:

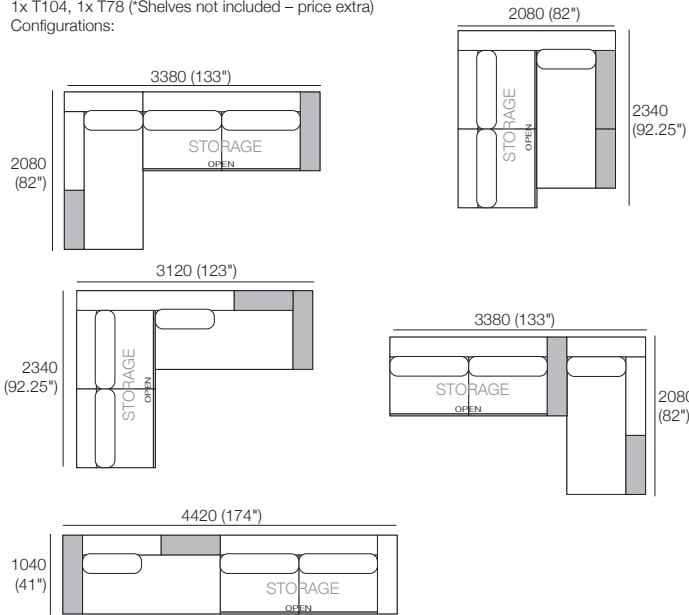

## Package: 9 SLH S234 SMART

Components: 1x SBase 234 S208 RH, 1x P208, 1x C182, 1x A208 SMART, 2x A104 SMART, 2x B104, 1x B78

Shelf Options\*: Standard or Charge

1x T104, 1x T78 (\*Shelves not included – price extra)

Configurations:

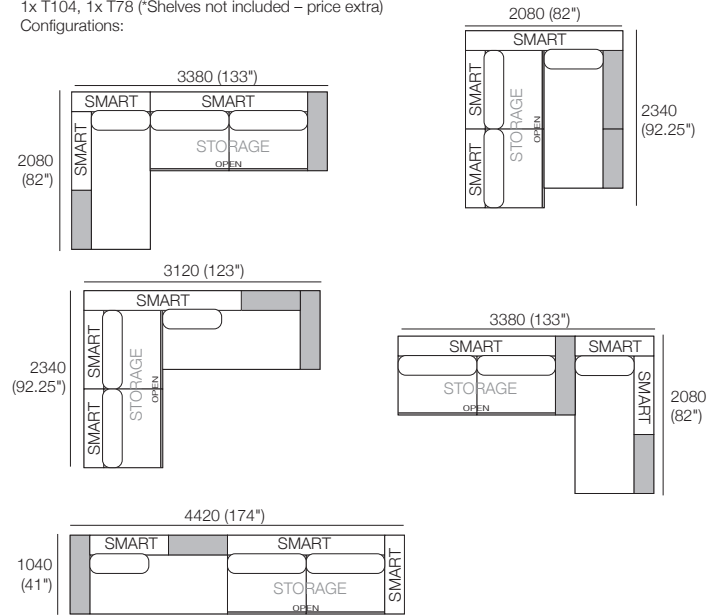

# Jasper II Packages 9

## Package: 9 SRH S234

Components: 1x SBase 234 C208 LH, 1x P208, 1x C182, 1x A208, 2x A104, 2x B104, 1x B78

Shelf Options\*: Standard or Charge

1x T104, 1x T78 (\*Shelves not included – price extra)

Configurations:

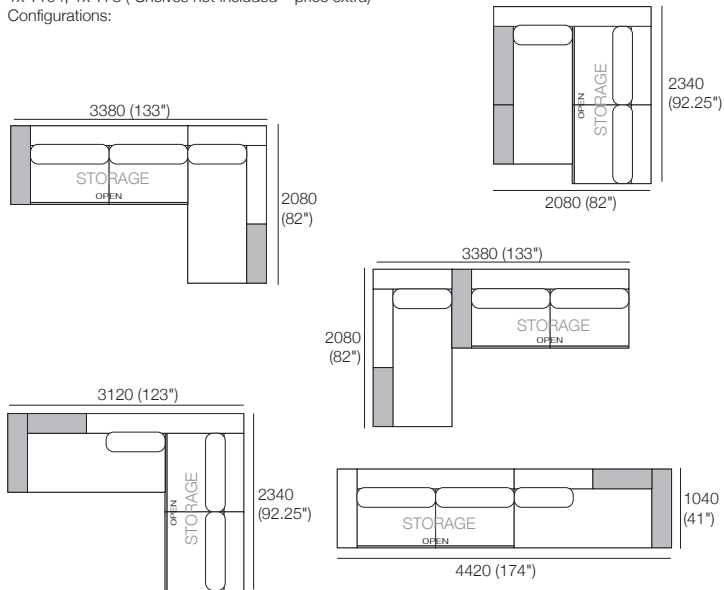

## Package: 9 SRH S234 SMART

Components: 1x S Base 234 C208 LH, 1x P208, 1x C182, 1x A208 SMART, 2x A104 SMART, 2x B104, 1x B78

Shelf Options\*: Standard or Charge

1x T104, 1x T78 (\*Shelves not included – price extra)

Configurations:

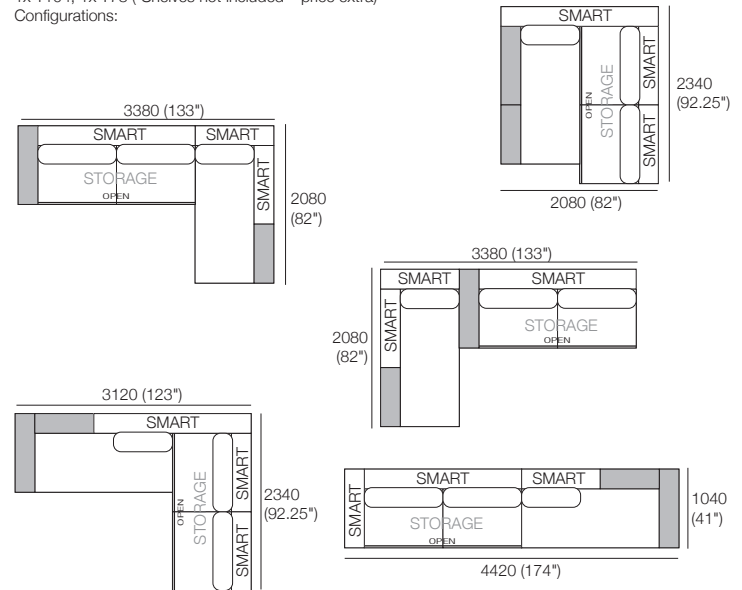

# Jasper II Packages 13

**KING**<sup>®</sup>  
L I V I N G



[kingliving.com](http://kingliving.com)

# Jasper II Packages 13

## Package: 13

Components: 2x P182, 2x C156,  
1x A104, 1x A156, 1x A78, 3x B78  
Shelf Options\*: Standard or Charge  
1x T104, 1x T78 (\*Shelves not included – price extra)  
Configurations:

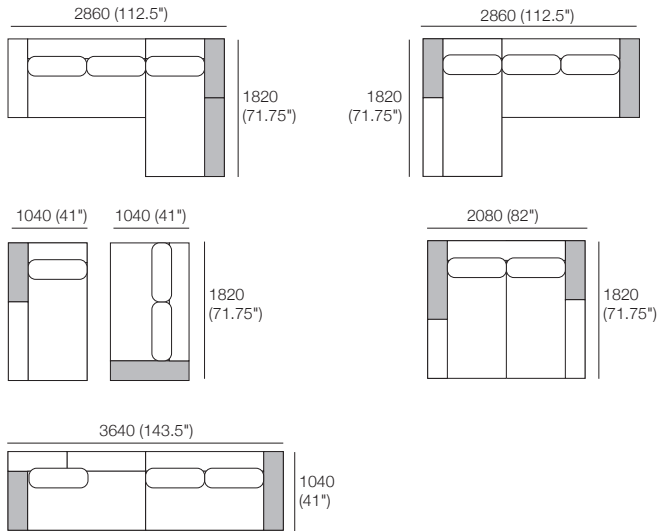

## Package: 13 SMART

Components: 2x P182, 2x C156,  
1x A104 SMART, 1x A156 SMART, 1x A78 SMART, 3x B78  
Shelf Options\*: Standard or Charge  
1x T104, 1x T78 (\*Shelves not included – price extra)  
Configurations:

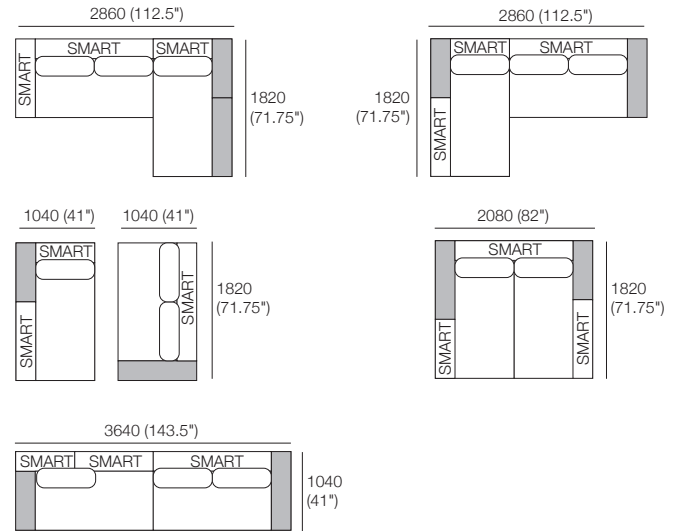

# Jasper II Packages 13

## Package: 13 SLH

Components: 1x SBase 182 S156 RH, 1x SBase 182 S78 LH,  
 1x A104, 1x A156, 1x A78, 3x B78  
 Shelf Options\*: Standard or Charge  
 1x T104, 1x T78 (\*Shelves not included – price extra)  
 Configurations:

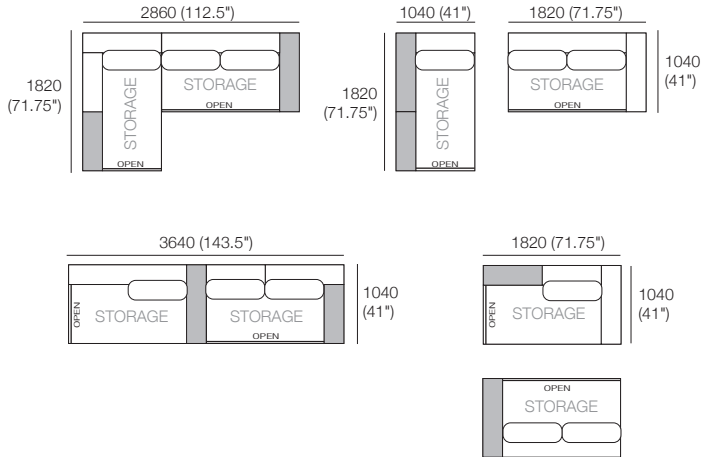

## Package: 13 SLH SMART

Components: 1x SBase 182 S156 RH, 1x SBase 182 S78 LH,  
 1x A104 SMART, 1x A156 SMART, 1x A78 SMART, 3x B78  
 Shelf Options\*: Standard or Charge  
 1x T104, 1x T78 (\*Shelves not included – price extra)  
 Configurations:

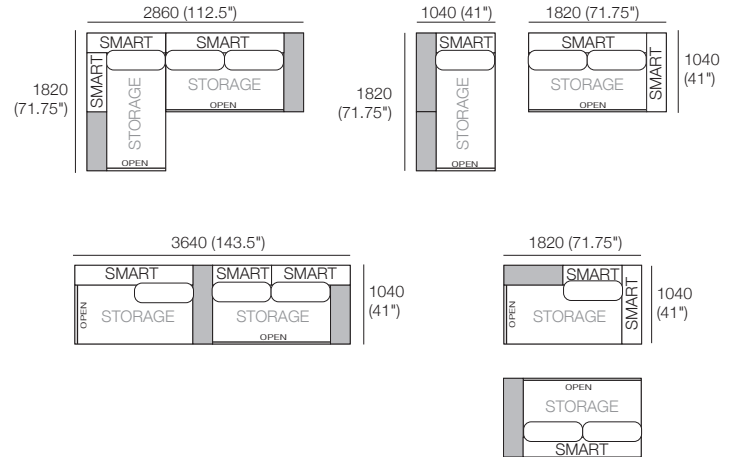

# Jasper II Packages 13

## Package: 13 SRH

Components: 1x SBase 182 S156 LH, 1x SBase 182 S78 RH,  
1x A104, 1x A156, 1x A78, 3x B78  
Shelf Options\*: Standard or Charge  
1x T104, 1x T78 (\*Shelves not included – price extra)  
Configurations:

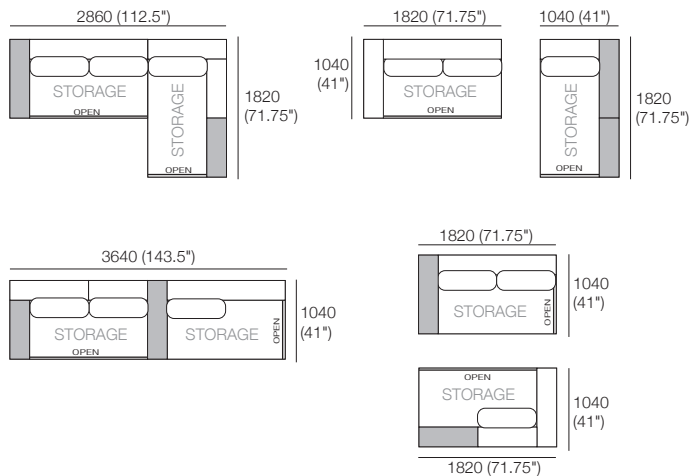

## Package: 13 SRH SMART

Components: 1x SBase 182 S156 LH, 1x SBase 182 S78 RH, 1x A104 SMART,  
1x A156 SMART, 1x A78 SMART, 3x B78  
Shelf Options\*: Standard or Charge  
1x T104, 1x T78 (\*Shelves not included – price extra)  
Configurations:

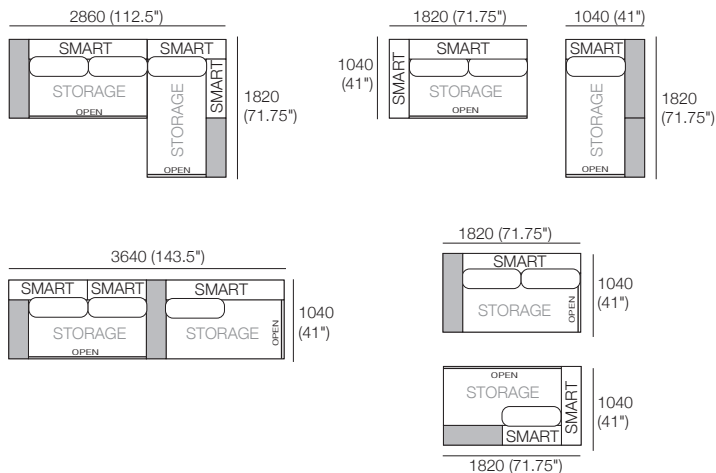

# Jasper II Packages 13U

**KING**<sup>®</sup>  
L I V I N G



[kingliving.com](http://kingliving.com)

# Jasper II Packages 13U

## Package: 13U

Components: 2x P182, 2x C156, 2x A104,  
1x A156, 2x A78, 3x B78  
Configurations:

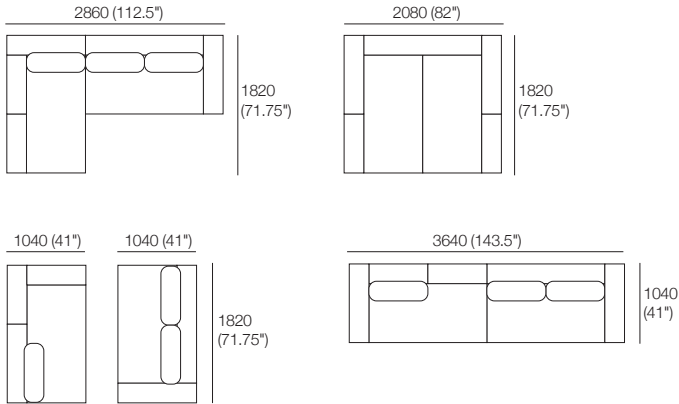

## Package: 13U SMART

Components: 2x P182, 2x C156, 2x A104 SMART,  
1x A156 SMART, 2x A78 SMART, 3x B78  
Configurations:

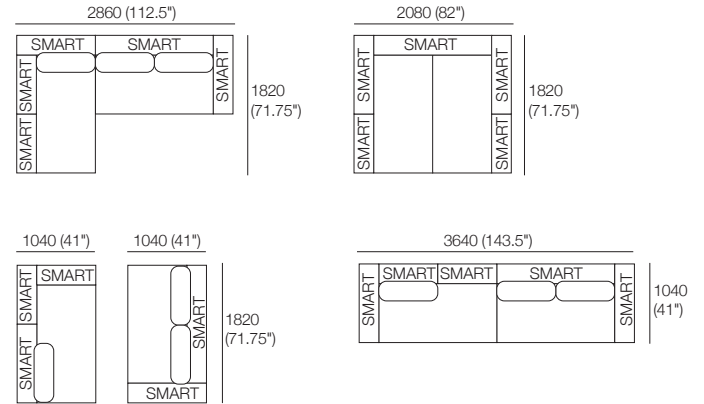



# Jasper II Packages 13U

## Package: 13U SLH

Components: 1x SBase 182 S156 RH, 1x SBase 182 S78 LH,  
1x A156, 2x A104, 2x A78, 3x B78

Configurations:

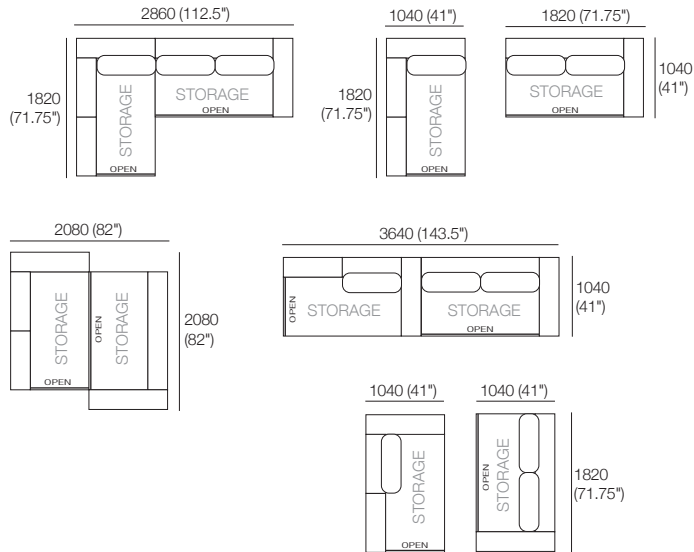

## Package: 13U SLH SMART

Components: 1x SBase 182 S156 RH, 1x SBase 182 S78 LH, 1x A156 SMART,  
2x A104 SMART, 2x A78 SMART, 3x B78

Configurations:

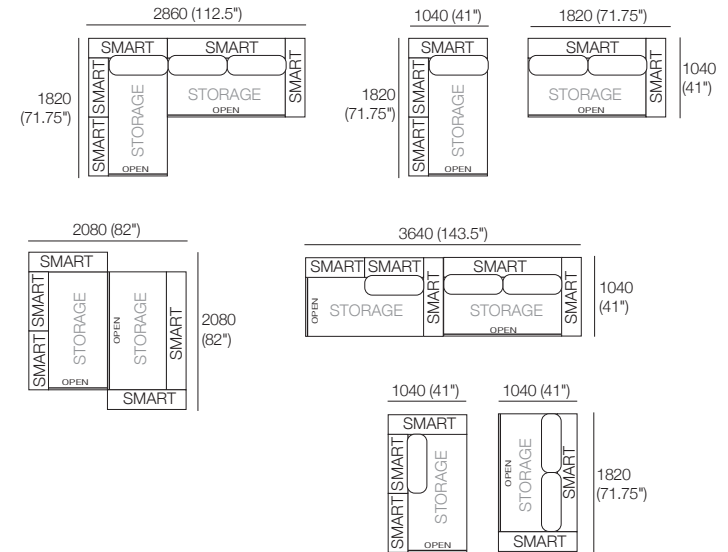

# Jasper II Packages 13U

## Package: 13U SRH

Components: 1x SBBase 182 S156 LH, 1x SBBase 182 S78 RH,

1x A156, 2x A104, 2x A78, 3x B78

Configurations:

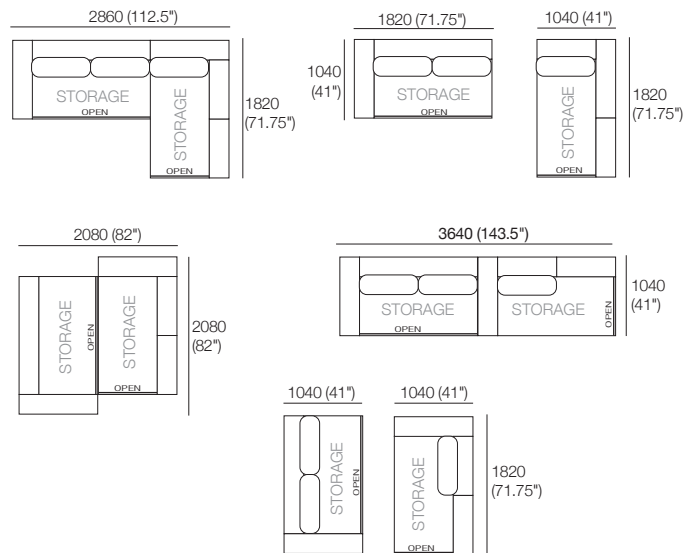

## Package: 13U SRH SMART

Components: 1x SBBase 182 S156 LH, 1x SBBase 182 S78 RH, 1x A156 SMART,

2x A104 SMART, 2x A78 SMART, 3x B78

Configurations:

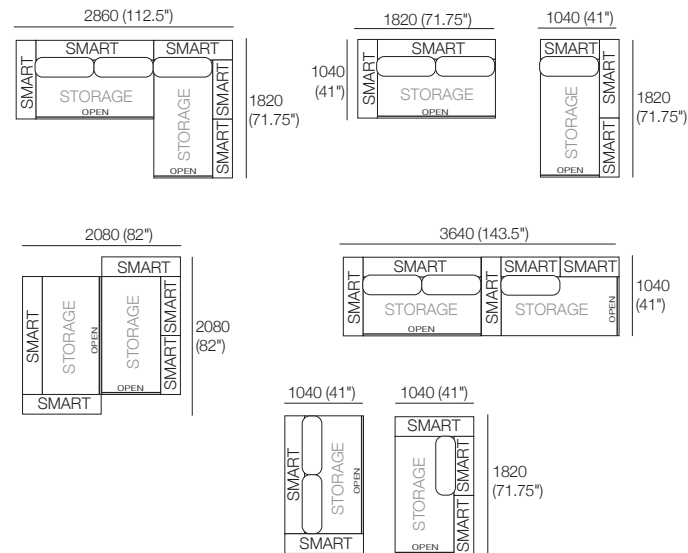

# Jasper II Packages Corner and End

**KING**<sup>®</sup>  
L I V I N G



[kingliving.com](http://kingliving.com)

# Jasper II Packages

## Corner and End

### Package: Corner 130

Components: 1x P130 Corner, 1x C104 78 Corner,  
1x A104, 1x A130, 1x B91, 1x B104

### Package: Corner 130 SMART\*

\*SMART Arms replace STD Arms

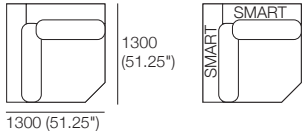

### Package: 2 STR END SLH

Components: 1x SBase 182 S156 LH, 1x A156, 2x B78.  
Shelf Options\*: Standard or Charge  
1x T104 (\*Shelves not included – price extra)

### Package: 2 STR END SLH SMART\*

\*SMART Arms replace STD Arms

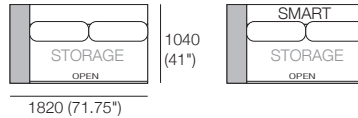

### Package: 2.5 STR END

Components: 1x P208, 1x C182, 2x A104, 2x B91  
Shelf Options\*: Standard or Charge  
1x T78 (\*Shelves not included – price extra)

### Package: 2.5 STR END SMART\*

\*SMART Arms replace STD Arms

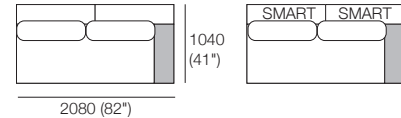

### Package: 2 STR END

Components: 1x P182, 1x C156, 1x A156, 2x B78.  
Shelf Options\*: Standard or Charge  
1x T104 (\*Shelves not included – price extra)

### Package: 2 STR END SMART\*

\*SMART Arms replace STD Arms

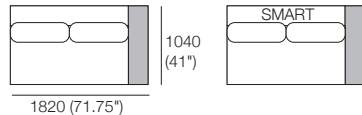

### Package: 2 STR END SRH

Components: 1x SBase 182 S156 RH, 1x A156, 2x B78.  
Shelf Options\*: Standard or Charge  
1x T104 (\*Shelves not included – price extra)

### Package: 2 STR END SRH SMART\*

\*SMART Arms replace STD Arms

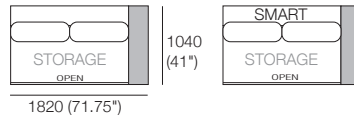

# Jasper II Package Chairs

**KING**<sup>®</sup>  
L I V I N G

## Package: Chair 104T

Components: 1x P104, 1x C78, 1x A78, 1x B78

Shelf Options\*: Standard or Charge

1x T104 (\*Shelves not included – price extra)

Configurations:

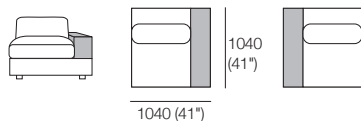

## Package: Chair 104T SMART

Components: 1x P104, 1x C78, 1x A78 SMART, 1x B78

Shelf Options\*: Standard or Charge

1x T104 (\*Shelves not included – price extra)

Configurations:

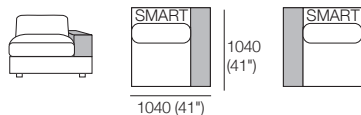

## Package: Chair 130T

Components: 1x P130, 1x C104, 1x A104, 1x B104

Shelf Options\*: Standard or Charge

1x T104 (\*Shelves not included – price extra)

Configurations:

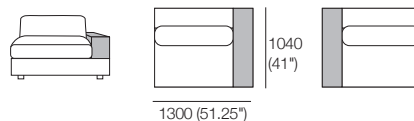

## Package: Chair 130T SMART

Components: 1x P130, 1x C104, 1x A104 SMART, 1x B104

Shelf Options\*: Standard or Charge

1x T104 (\*Shelves not included – price extra)

Configurations:

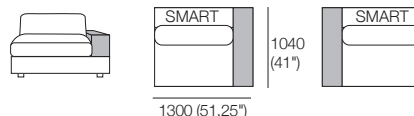

# Jasper II Packages 7W

7W + 7W SLH + 7W SRH

**KING**<sup>®</sup>  
L I V I N G



# Jasper II Packages 7W

**Packages: 7W + 7W SMART\*** (\*SMART Arms replace STD Arms)

Components: 1x P208, 1x P208D, 1x P234, 1x C182D, 1x C182, 2x C104, 4x A104, 1x A208, 3x B104, 1x B78

Shelf Options\*: Standard or Charge

2x T104, 1x T78 (\*Shelves not included – price extra)

Configurations:

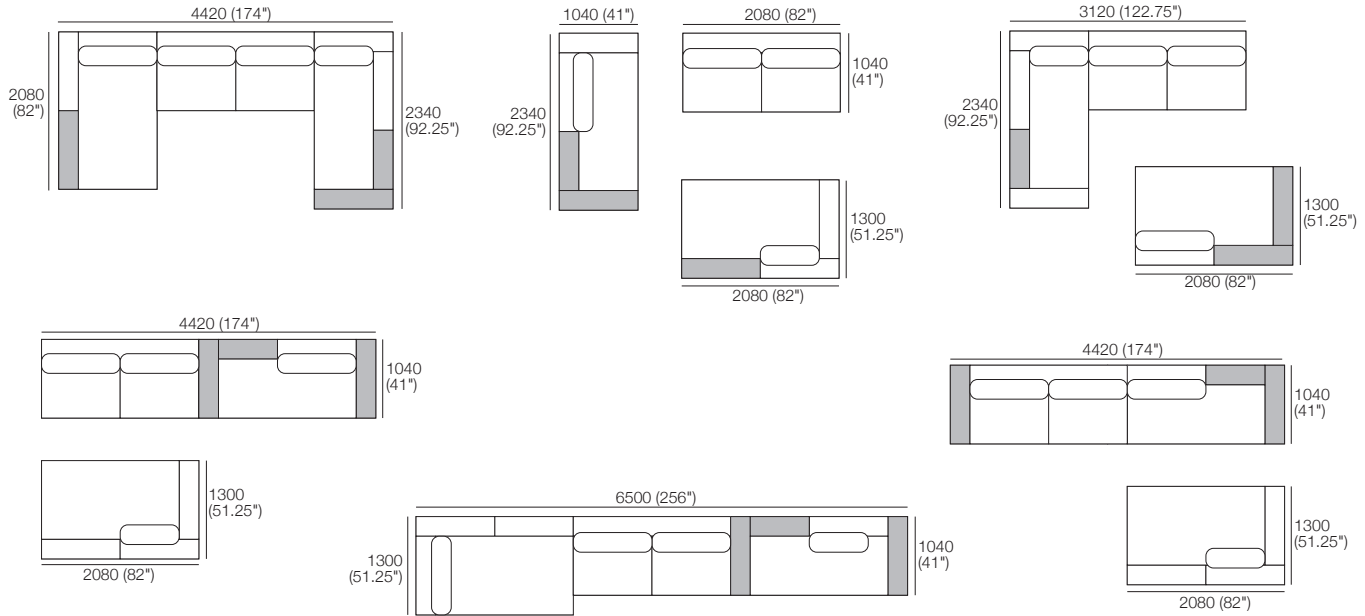

# Jasper II Packages 7W SRH

**Packages: 7W SRH208D + 7W SRH208D SMART\*** (\*SMART Arms replace STD Arms)

Components: 1x S Base 208D S104 RH, 1x P208, 1x P234, 1x C182, 2x C104, 4x A104, 1x A208, 3x B104, 1x B78

Shelf Options\*: Standard or Charge

2x T104, 1x T78 (\*Shelves not included – price extra)

Configurations:

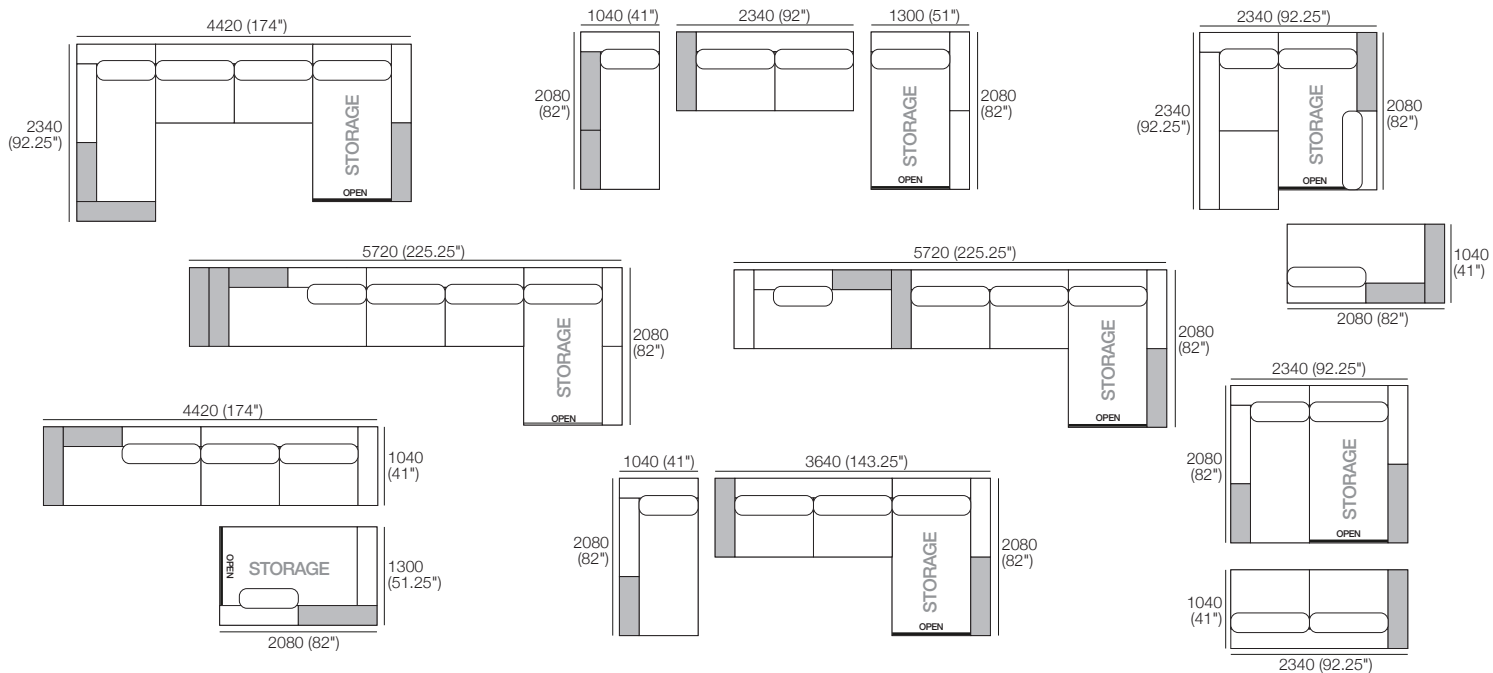

Effective June 2020. Use Magic Joiner M115. \*Shelf Options: Standard or Charge (not included in package – price extra) available in selected King Living Timber Finishes. \*SMART Packages: SMART Arms replace STD Arms. As King Living has a policy of continuous improvement, changes to products and specifications may be made without prior notice. Images and drawings are representative of design only. Accessories not included.



# Jasper II Packages 7W SLH

## Packages: 7W SLH208D + 7W SLH208D SMART\* (\*SMART Arms replace STD Arms)

Components: 1x S Base 208D S104 LH, 1x P208, 1x P234, 1x C182, 2x C104, 4x A104, 1x A208, 3x B104, 1x B78

Shelf Options\*: Standard or Charge

2x T104, 1x T78 (\*Shelves not included – price extra)

Configurations:

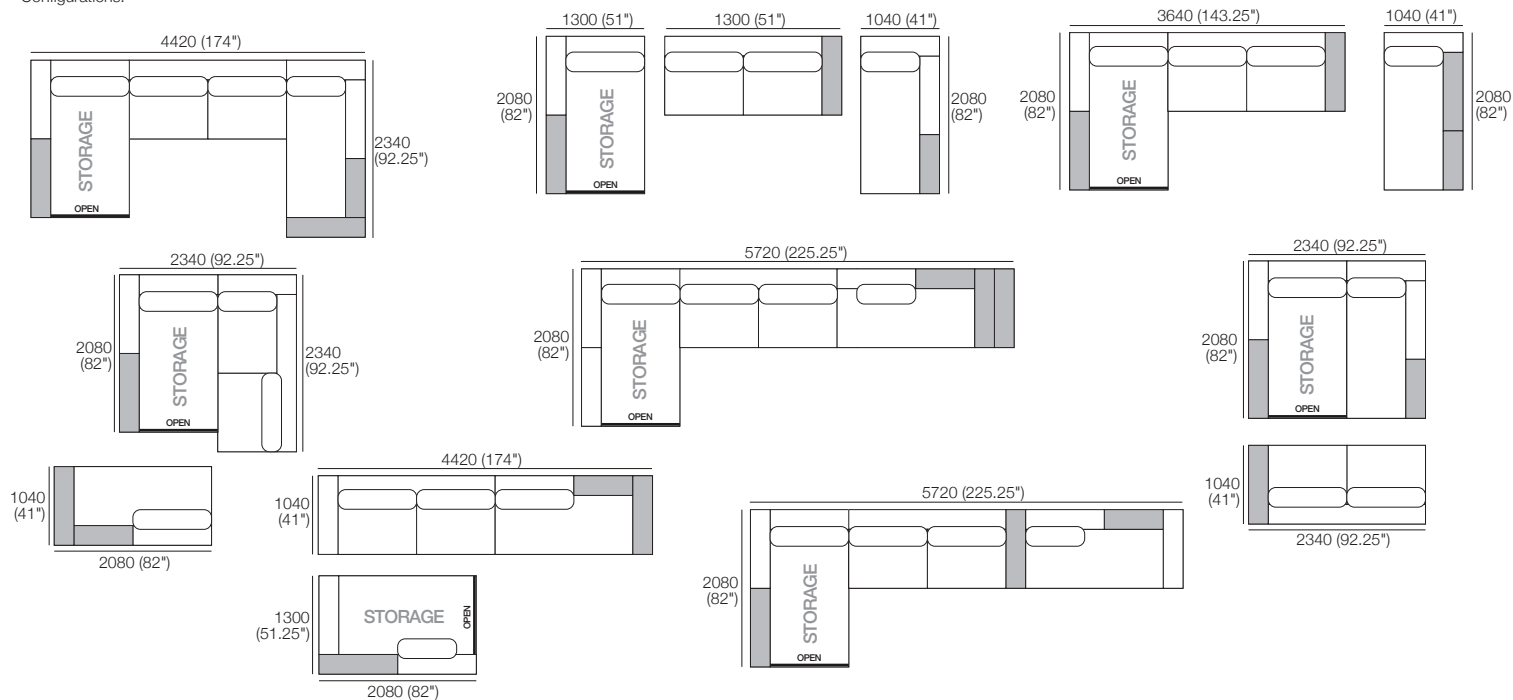

Effective June 2020. Use Magic Joiner M115. \*Shelf Options: Standard or Charge (not included in package – price extra) available in selected King Living Timber Finishes. \*SMART Packages: SMART Arms replace STD Arms. As King Living has a policy of continuous improvement, changes to products and specifications may be made without prior notice. Images and drawings are representative of design only. Accessories not included.